

Junction Boxes

Series 8118

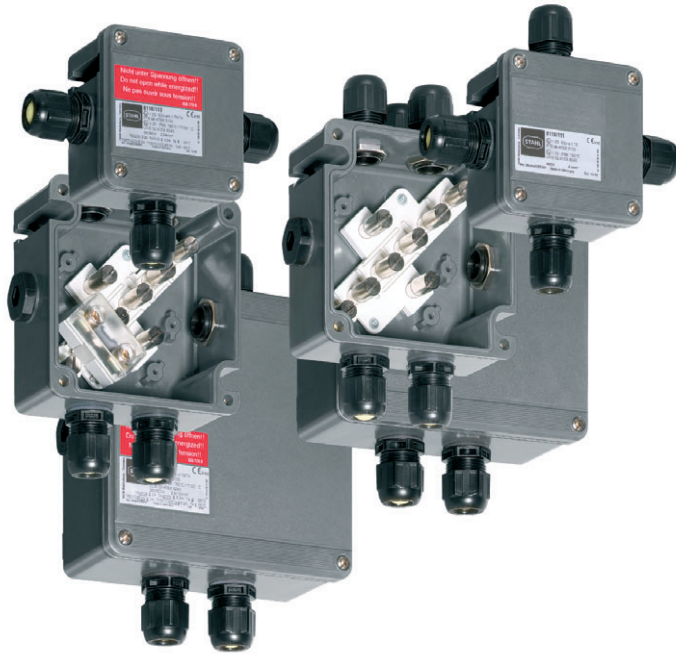

- > Enclosure in glass fibre reinforced polyester resin
- > 3 different sizes available
 - with 4, 5 or 8 terminals
 - as a junction box with integrated miniature fuse:
 - 3 terminals and 1 miniature fuse
 - 7 terminals and 1 miniature fuse
 - 6 terminals and 2 miniature fuses
- > Degree of protection IP66

E3

www.stahl.de



02714E00

Series 8118 junction boxes are used to transport and distribute electrical energy in areas subject to explosion hazards. Three different sizes of robust enclosures made of glass fibre reinforced polyester resin are available. They are equipped with mantle terminals or with mantle terminals and miniature fuses. The junction boxes are therefore not only suitable as simple connection or distribution boxes but also for protecting electrical loads up to 6.3 A. In the standard version, plastic cable glands are used. If required, metal cable glands which can be installed in the earthing system by means of brass plates or cable glands with strain relief are available.



















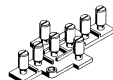

Zone	ATEX / IECEx					
	0	1	2	20	21	22
For use in		x	x		x	x

WebCode 8118A

Junction Boxes

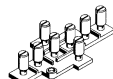
Series 8118

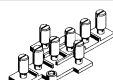



Selection Table

Version	Cable glands					Order number	Weight kg
	Position	Holes	Cable glands	Stopping plugs			
Ex e version size 1  01658E00	 05349E00 4 terminals	 09147E00	3 x M20 x 1.5	2 x M20 x 1.5	1 x M20 x 1.5	8118/111-401	0.280
	 05576E00 5 terminals	 09148E00	4 x M20 x 1.5	3 x M20 x 1.5	1 x M20 x 1.5	8118/111-503	0.300
	number of terminals according to the order	number of holes acc. to order	--	--	--	8118/111- .99	--
Ex i version size 1  01548E00	 05349E00 4 terminals	 09147E00	3 x M20 x 1.5	2 x M20 x 1.5	1 x M20 x 1.5	8118/211-401	0.280
		 09148E00	4 x M20 x 1.5	3 x M20 x 1.5	1 x M20 x 1.5	8118/211-403	0.330
	number of terminals according to the order	number of holes acc. to order	acc. to order	acc. to order	acc. to order	8118/211- .99	--
Ex e version size 2  01655E00	 05348E00 8 terminals	 09149E00	4 x M25 x 1.5	3 x M25 x 1.5	1 x M25 x 1.5	8118/121-805	0.570
		 09151E00	6 x M20 x 1.5	4 x M20 x 1.5	2 x M20 x 1.5	8118/121-806	0.560
		 09153E00	6 x M25 x 1.5	4 x M25 x 1.5	2 x M25 x 1.5	8118/121-807	0.600
	 05578E00 5 terminals	 09150E00	4 x M25 x 1.5	4 x M25 x 1.5	--	8118/121-538	0.625
			2 x M25 x 1.5	2 x M25 x 1.5	--	8118/121-539	0.600
	number of terminals according to the order	number of holes acc. to order	--	--	--	8118/121- .99	--
Ex i version size 2  10549E00	 05348E00 8 terminals		number of holes acc. to order	acc. to order	acc. to order	8118/221-899	--
Ex e version size 3  01654E00	 05348E00 8 terminals	 09155E00	6 x M32 x 1.5	4 x M32 x 1.5	2 x M32 x 1.5	8118/131-811	0.850
		 09154E00	8 x M25 x 1.5	6 x M25 x 1.5	4 x M25 x 1.5	8118/131-814	0.850
	Number of terminals and fuses acc. to order	number of holes acc. to order	--	--	--	8118/131- .99	--

Junction Boxes

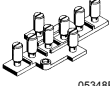
Series 8118

Selection Table

Version	Cable glands			Order number	Weight kg		
	Position	Holes	Cable glands			Stopping plugs	
Ex i version size 3  10550E00	 05348E00 8 terminals	number of holes acc. to order	acc. to order	acc. to order	8118/231-899	--	
Ex e version size 1  01652E00	 05384E00 3 terminals + 1 fuse	 09148E00	4 x M20 x 1.5	2 x M20 x 1.5	2 x M20 x 1.5	8118/113-303	0.330
Ex e version size 2  01650E00	Number of terminals and fuses acc. to order	number of holes acc. to order	--	--	8118/123-.99	--	

Note

Standard: cable glands, Series 8161
 Option: metal cable glands with brass plate
 A non-standard arrangement is possible when using cable glands of the Series 8161
 as well as when using cable glands with strain relief.

Cable glands and stopping plugs are enclosed separately.

The fuse must be ordered separately.

Explosion Protection
Marking

Versions Type IECEX	Junction box without miniature fuse			Junction box with miniature fuse	
	8118/.11	8118/.21	8118/.31	8118/113	8118/123
Gas explosion protection	Ex e Ex i	Ex e II T6, T5, T4 Ex ia/ib IIA, IIB, IIC T6, T5		Ex em II T * * depending on miniature fuse used	
Dust explosion protection Europe (ATEX)	Ex tD A21 IP66 T80 °C, T95 °C, T130 °C			Ex tD A21 IP66 T80 °C, T95 °C, T130 °C	
Gas explosion protection	Ex e Ex i	⊕ II 2 G Ex e II T6, T5, T4 ⊕ II 2 G Ex ia/ib IIA, IIB, IIC T6, T5		⊕ II 2 G Ex em II T * * depending on miniature fuse used	
Dust explosion protection	⊕ II 2 D Ex tD A21 IP66 T80°C, T95°C, T130°C			⊕ II 2 D Ex tD A21 IP66 T80°C, T95°C, T130°C	

Certificates

IECEX
 Europe (ATEX)
 Other certificates

IECEX PTB 06.0026
 PTB 99 ATEX 3103
 Brazil (UL do Brasil), China (CQST Ex), India (PESO), Kazakhstan (JSC), Korea (KGS),
 Russia (CTB), Ukraine (ISCVE)

Junction Boxes

Series 8118

Technical Data

Electrical data						
Versions Type	Junction box without miniature fuse			Junction box with miniature fuse		
	8118/.11	8118/.21	8118/.31	8118/113	8118/123	
Nominal voltage	550 V	750 V	750 V	250 or 500 V depending on miniature fuse used		
Connection terminals						
Current carrying capacity at conductor cross-section of	max. 24 A 4 mm ²	max. 32 A 6 mm ²	max. 44 A 10 mm ²	max. 24 A 4 mm ²	max. 32 A 6 mm ²	
Max. number of miniature fuses	--	--	--	1 x 8560	2 x 8560	
Ambient conditions						
Ambient temperature	Ex e: - 20 ... + 55 °C - 50 ... + 55 °C with special cable glands Ex i: - 20 ... + 75 °C - 50 ... + 75 °C with special cable glands					
Mechanical data						
Degree of protection	IP66					
Material						
Enclosure	glass fibre reinforced polyester resin, dark grey similar to RAL 7012, impact resistance > 7 J, flame retardant acc. to IEC/EN 60695, UL 94, ASTM D635					
Sealing gasket	Polyurethane, foamed					
Cover fixing	with captive M4 stainless steel combo head screws or					
Mounting / Installation						
Versions Type	Junction box without miniature fuse			Junction box with miniature fuse		
	8118/.11	8118/.21	8118/.31	8118/113	8118/123	
Cable gland						
Standard	Cable glands, series 8161 and stopping plugs, series 8290 are enclosed separately.			Cable glands, series 8161 and stopping plugs, series 8290 are enclosed separately.		
	3 x M20 4 x M20	6 x M20 4 x M25 6 x M25	8 x M25 6 x M32	--	--	
Special version	Holes according to order. Metal cable glands with brass plates or cable entry glands are possible.			Holes according to order. Metal cable glands with brass plates or cable entry glands are possible.		
Connection terminals						
Type of terminals	mantle terminals	mantle terminals	mantle terminals	mantle terminals	mantle terminals	
Max. number	4 or 5	5 or 8	8	3 when using 1 miniature fuse	7 when using 1 miniature fuse, 6 when using 2 miniature fuses	
Max. conductor cross-section	4 mm ² solid	6 mm ² solid	10 mm ² solid	4 mm ² solid	6 mm ² solid	

Junction Boxes

Series 8118

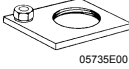
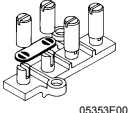
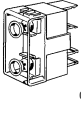

Accessories and Spare Parts

Designation	Illustration	Description	Order number	Weight kg	
Brass plate with thread		for earth continuity when metal cable glands are used			
		for cable glands	can be fitted into enclosure Size 1 Size 2 Size 3		
		1 x M20 x 1.5	Side C / D Side C / D Side C / D	133208	0.030
		1 x M25 x 1.5 1 x M32 x 1.5 2 x M20 x 1.5	Side C / D Side C / D	133182	0.060
		2 x M25 x 1.5	Side C / D Side C / D	133198	0.080
		2 x M32 x 1.5	Side C / D	133202	0.140
Cross connector			8118/1.	133348	0.002
			8118/2.	133366	0.003
			8118/3.	133385	0.005
		for bridging 2 side by side mantle terminals			
Fuse		8560/51, 250 V UC			
		I_n [A]	Packaging units [pieces]		
		0.032	5	8560/51-4021	0.210
		0.05	5	8560/51-4031	0.210
		0.063	5	8560/51-4041	0.210
		0.08	5	8560/51-4051	0.210
		0.1	5	8560/51-4061	0.210
		0.125	5	8560/51-4071	0.210
		0.16	5	8560/51-4081	0.210
		0.2	5	8560/51-4091	0.210
		0.25	5	8560/51-4101	0.210
		0.315	5	8560/51-4111	0.210
		0.4	5	8560/51-4131	0.210
		0.5	5	8560/51-4141	0.100
		0.63	5	8560/51-4151	0.210
		0.8	5	8560/51-4171	0.210
		1.0	5	8560/51-4181	0.210
		1.25	5	8560/51-4191	0.210
		2.0	5	8560/51-4222	0.210
		4.0	5	8560/51-4252	0.210
		8560/61, 500 V UC			
		I_n [A]	Packaging units [pieces]		
		0.08	5	8560/61-4051	0.210
		0.1	5	8560/61-4061	0.210
		0.125	5	8560/61-4071	0.210
		0.2	5	8560/61-4091	0.210
		0.25	5	8560/61-4101	0.210
0.315	5	8560/61-4111	0.210		
0.4	5	8560/61-4131	0.210		
0.5	5	8560/61-4141	0.210		

E3

Junction Boxes

Series 8118

Dimensional Drawings (All Dimensions in mm) - Subject to Alterations

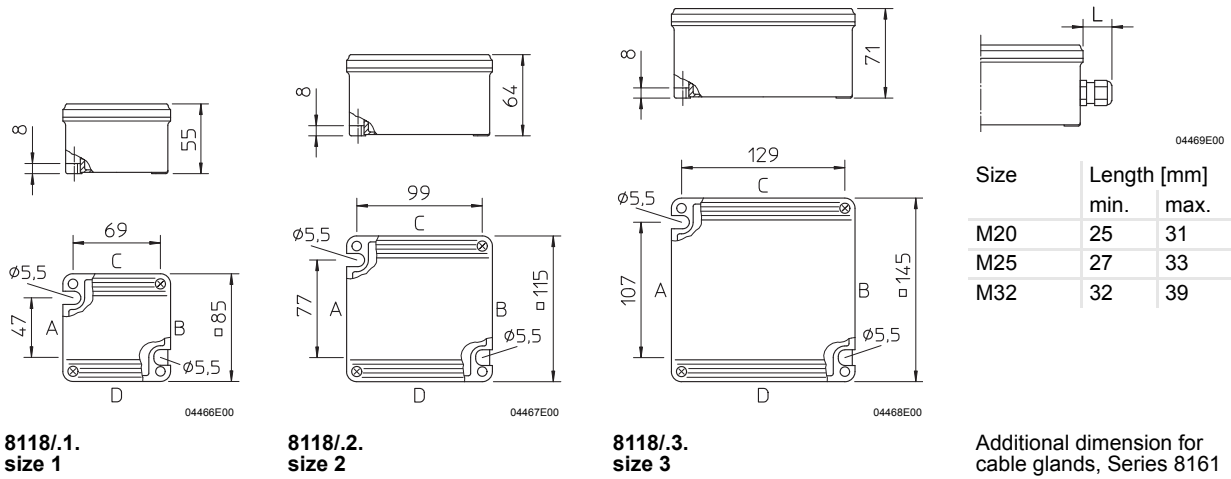

We reserve the right to make alterations to the technical data, dimensions, weights, designs and products available without notice. The illustrations cannot be considered binding.